

ASCENSORI COMPONENT

PRESENTAZIONE AZIENDA



PRODOTTI

La gamma dei prodotti che gestiamo differisce per marca e tipologia, così da soddisfare sempre e al meglio le diverse richieste che pervengono ai nostri uffici e comprende :



CONTATTI

- *Ascensori Component di Fabio Granieri*
 - *Via delle Genziane n° 22*
 - *48015 Cervia (RA)*
 - *Mob. 3923151230 -- Uff/Fax 0544956496*
 - *info@ascensoricomponent.com*
 - *amministrazione@ascensoricomponent.com*
 - *commerciale@ascensoricomponent.com*
 - *www.ascensoricomponent.com*
 - *Skype : ascensoricomponent*
 - *Facebook : Ascensori Component di Fabio Granieri*
-
-

Guide TLH del tipo regolamentare, corredate di staffe e bulloneria

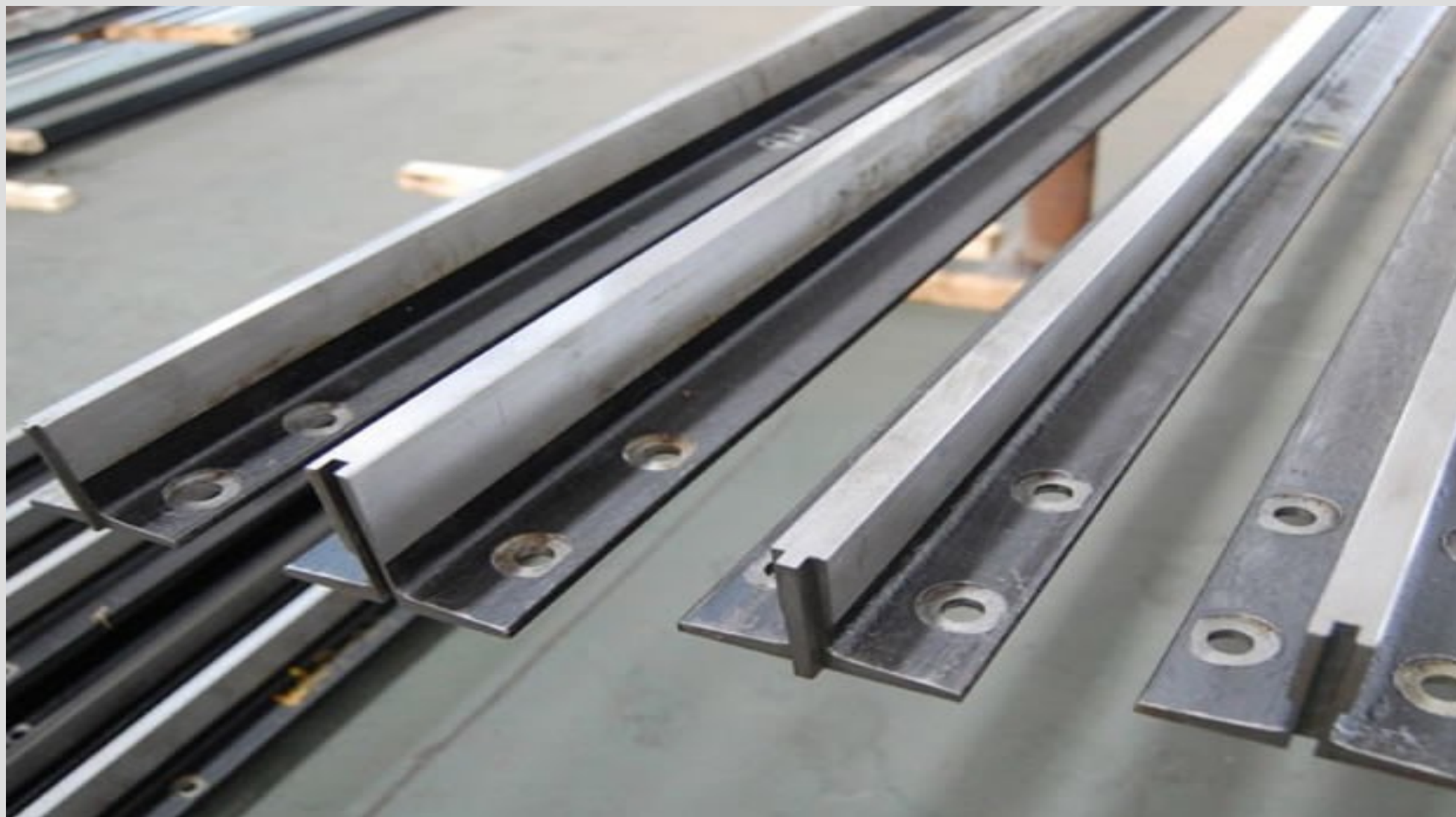

Officina per la produzione di staffe su disegno del cliente



Arcate per impianti elettrici ed oleodinamici,

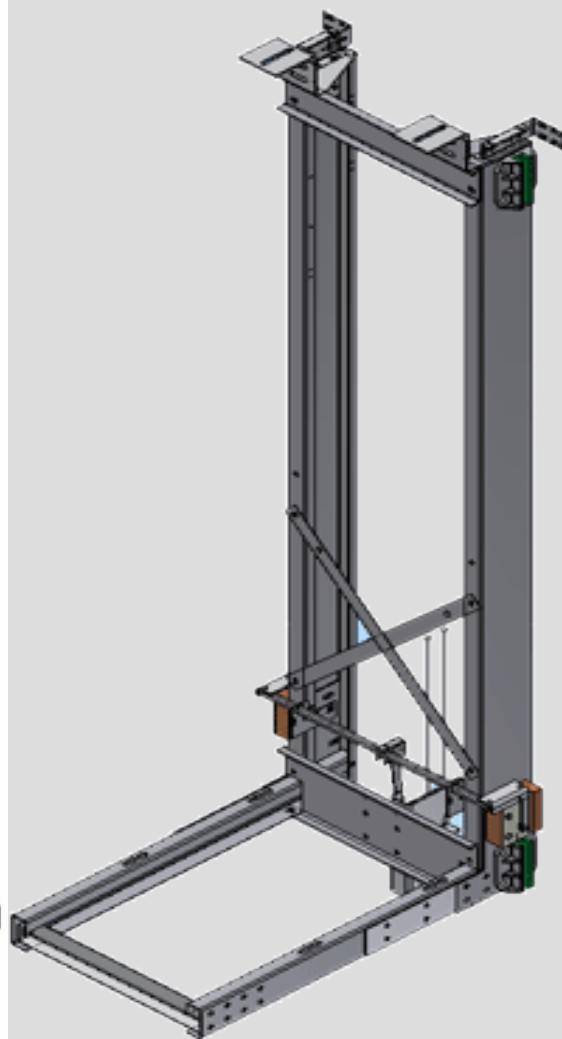
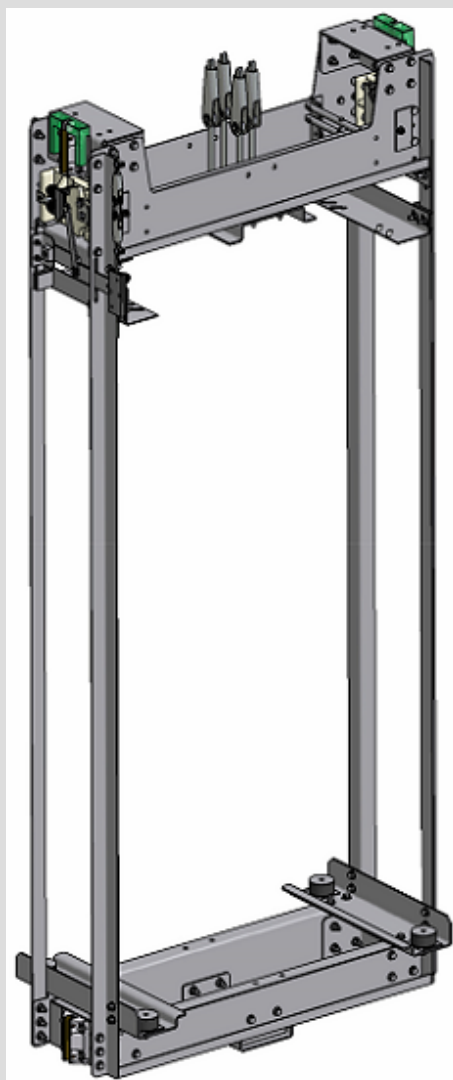

L'eccellenza dei nostri partners

**Tuboflex da 1"1/2 – 1"1/4 – 2"
Tagliato a misura e disponibile in 24 ore**

- **MADE IN ITALY**

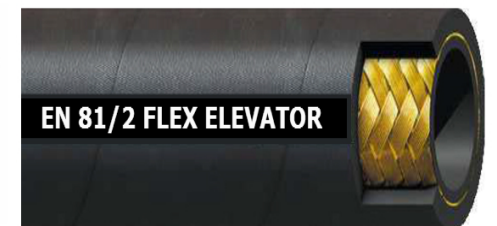

Funi acciaio sempre disponibili



Cavo flessibile e filo unipolare sempre disponibile



Pistoni e Centraline delle migliori marche



Argani e puleggie

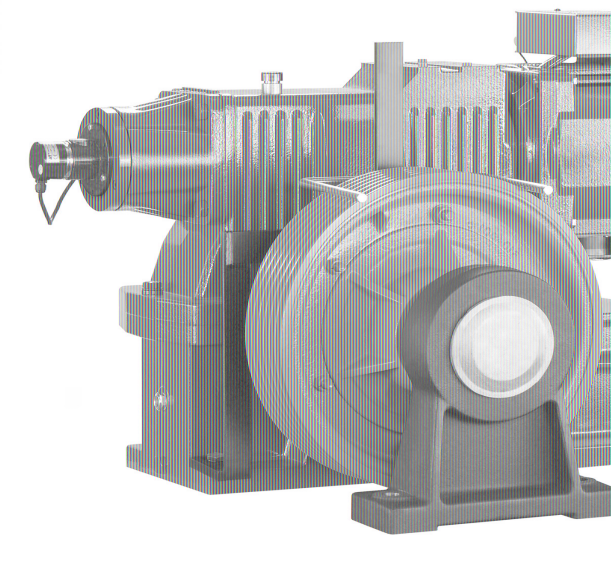
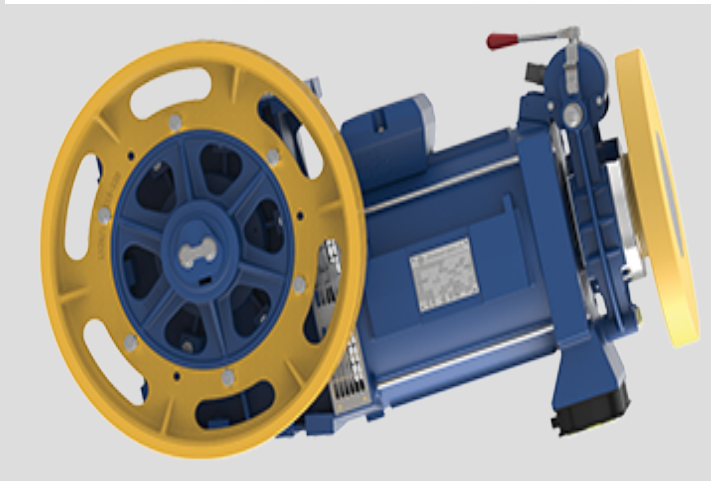
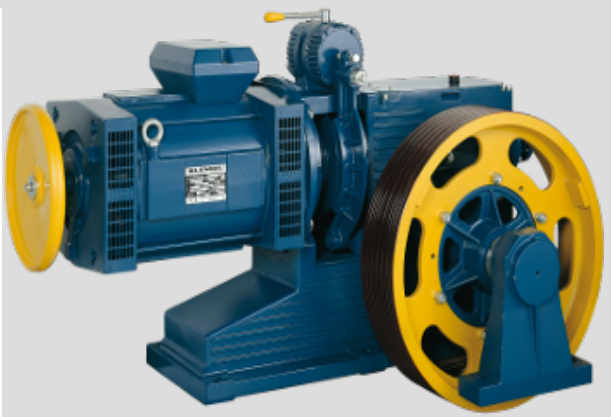

Accessori cabina e telai di piano



Illuminazione

Pannelli a led di nuova generazione ultra sottili (1cm)



Batterie e Alimentatori



Operatori e Sospensioni

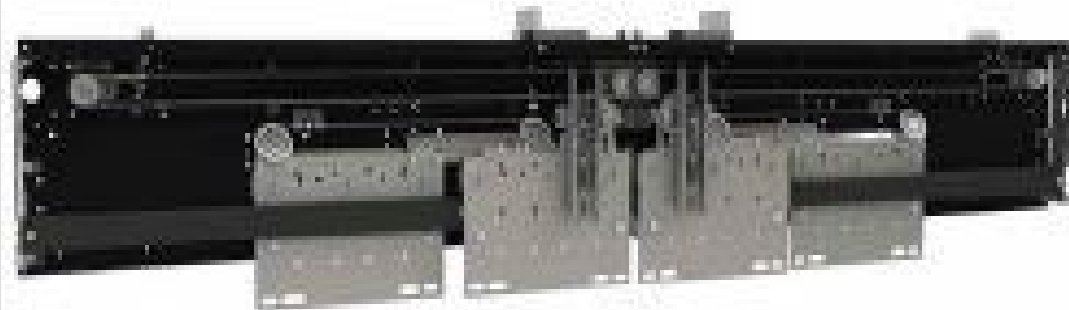
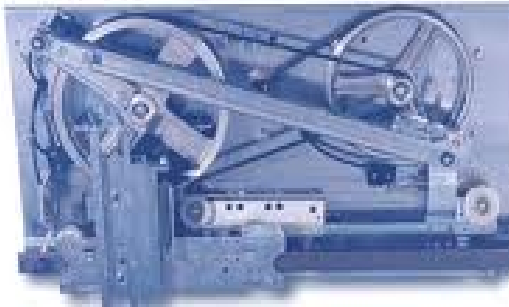
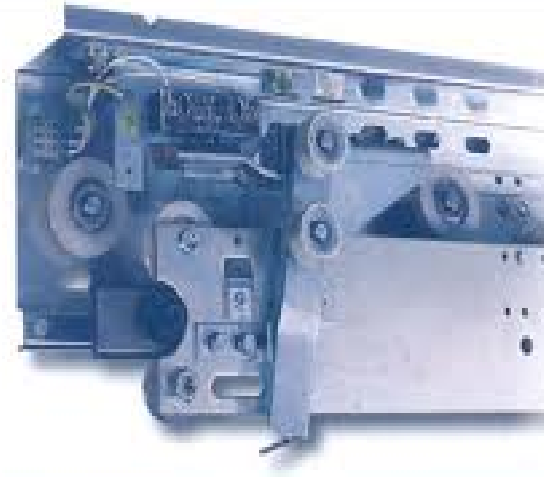
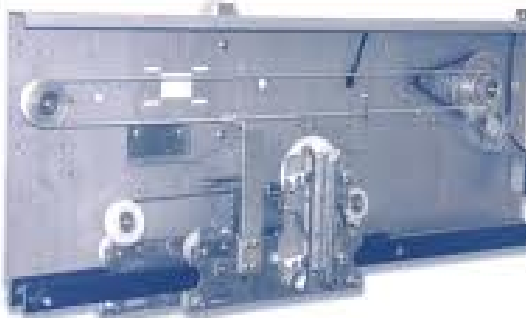

Quadri di manovra Fune / Oleo sempre disponibili



**Porte del tipo semi - automatico ad uno e due battenti
Telai completi di ante per ogni tipo di automatismo**



Quadretto modulare locale macchina

IL KIT CONTIENE:

INTERRUTTORE MAGNETOTERMICO 1X10A+N CURVA C 4,5/6KA

INTERRUTTORE MAGNETOTERMICO 1X16A+N CURVA C 4,5/6KA

INTERRUTTORE MAGNETOTERMICO 3X40A/32A/25A CURVA C 6KA

INTERRUTTORE DIFFERENZIALE PURO 2X25A/0,03 (PFIM-25/2/003)

BLOCCO INTERRUTTORE DIFFERENZIALE 3X40A/32A/25A/0,3
(PBSM-403/03)

GEMMA LUMINOSA S/B DIN 220V TRASP. (Z-L)

DISPOSITIVO BLOCCO LEVA INTERRUTTORE (HA7-SPE/1TE)

CONTENITORE QUADRETTO IP40 12M 292X257X120 S/SPOR



OLIO IDRAULICO

OLIO IDRAULICO ISO 46/68 IN TANICHE DA 20/25/60 E/O CISTERNE DA 1000 LITRI



Comunicazione



The screenshot shows a web application interface for 'dedalo'. The browser address bar displays 'dedalo.72ore.it/index.php'. The page features a navigation menu on the left and a main content area on the right. The main content area includes a status bar with 'ATTENZIONE: SONO SCATTATI NUOVI ALLARMI' and 'Attenzione: IMPIANTI NON COMUNICANTI'. Below this is a 'FILTRO EVENTI' section with 'INFO' and 'NOTE' tabs. The 'AZIENDA: TELEDIF ITALIA' is displayed. A table of events is shown with columns for ID, IMPIANTO, DESCRIZIONE, NOME IMPIANTO, DATA, and NOTIFICA. The table contains 15 rows of data, including entries for 'BATTERIA SCARICA' and 'TELEDIAGNOSI'. The footer of the page indicates 'SITO OTTIMIZZATO PER FIREFOX E CHROME' and 'POWERED BY TELEDIF ITALIA SRL'.

ID	IMPIANTO	DESCRIZIONE	NOME IMPIANTO	DATA	NOTIFICA
888980	1	BATTERIA SCARICA	AURELIO 3	05-11-2010 08:24:18	
888979	1	BATTERIA SCARICA	AURELIO 3	04-11-2010 16:57:03	
888978	1	BATTERIA SCARICA	AURELIO 3	04-11-2010 10:24:49	
888977	1	TELEDIAGNOSI	AURELIO 3	04-11-2010 10:22:58	
888976	1	TELEDIAGNOSI	AURELIO 3	03-11-2010 10:13:44	
888975	1	BATTERIA SCARICA	AURELIO 3	03-11-2010 10:13:25	
888967	1	TELEDIAGNOSI	AURELIO 3	19-10-2010 09:07:12	
888966	1	TELEDIAGNOSI	AURELIO 3	18-10-2010 16:33:22	
888965	1	TELEDIAGNOSI	AURELIO 3	17-10-2010 22:02:22	
888964	1	TELEDIAGNOSI	AURELIO 3	17-10-2010 22:02:10	
888963	1	BATTERIA SCARICA	AURELIO 3	17-10-2010 22:01:39	
888962	1	BATTERIA SCARICA	AURELIO 3	17-10-2010 22:01:00	





TRASPORTI

IL NOSTRO LAVORO E' COME SEMPRE RIVOLTO A CONTENERE LE DIFFICOLTA' E LE CONTINGENZE PROPRIE DELL'ATTIVITA' D'IMPRESA, NASCE OGGI " VENGO IO "

AFFIDA A NOI LA GESTIONE DEI TUOI TRASPORTI

IL SERVIZIO E' ALTAMENTE PROFESSIONALE, PRATICO E NON RICHIEDE NESSUNO SFORZO TECNICO SE NON QUELLO RELATIVO ALLA TRASMISSIONE DEI DOCUMENTI PROPRI DEL TRASPORTO.

FLESSIBILITA'RAPIDITA'CONVENIENZA

